

SBGN PD

Current status, future changes and
unresolved issues

COMBINE 2010

Process Description Language

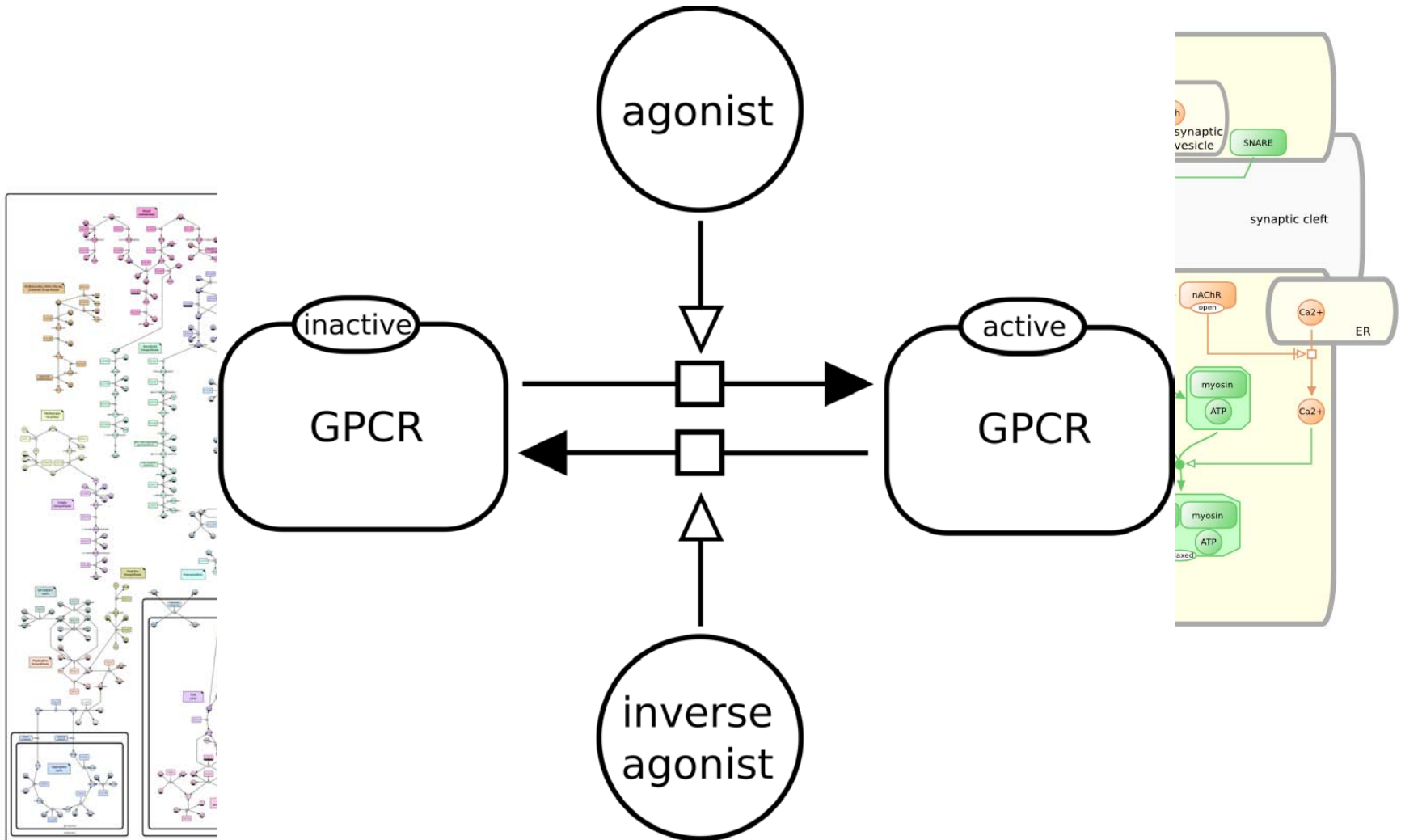

PD Specification

- Level 1 Version 1: Sep 2008
 - Original specification
- Level 1 Version 1.1: Sep 2009
 - Fixed inconsistencies
 - Typos
 - Clarified “ontology” of glyphs
 - Nomenclature changes for consistency with other languages
- Level 1 Version 1.2: Oct 2010
 - Minor changes of clarity
 - Document errors

Level 1 Version 2.0

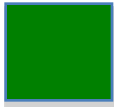

State Glyph Change

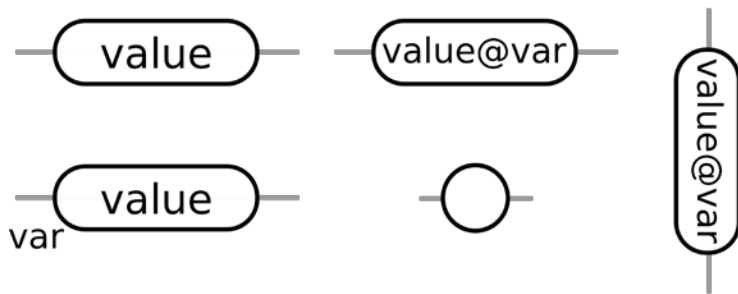

New Annotation Glyph



Reversible Arc

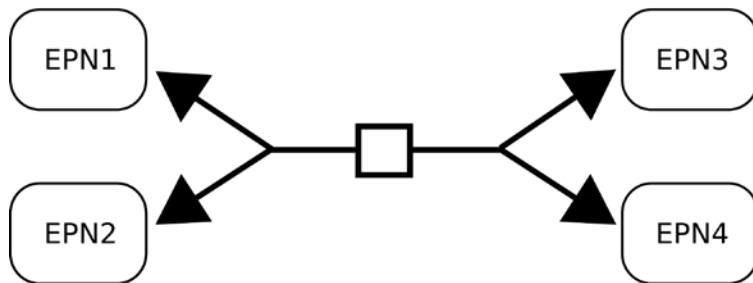

Subunits are not EPNs

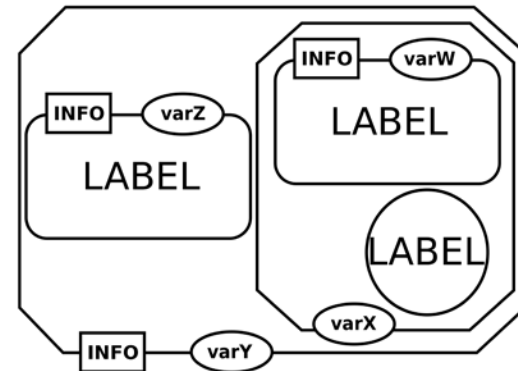

Level 1 Version 2.0

Submap / Functional Decomposition

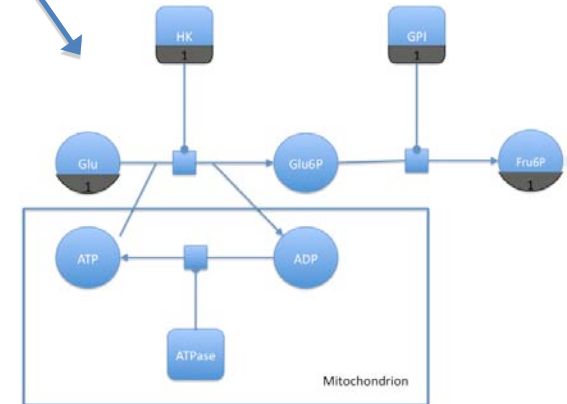
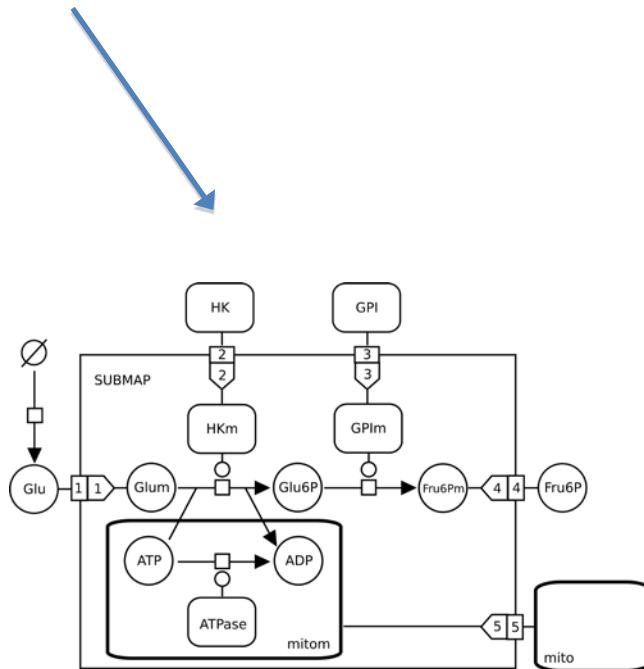
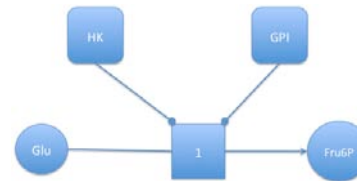
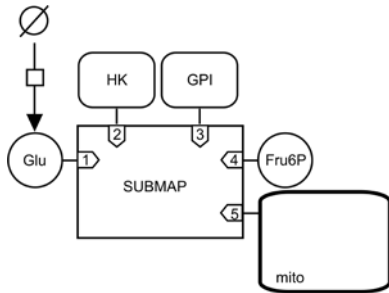

Future Issues (L2/L1V2)

Merge Simple Chemical/Macromolecule

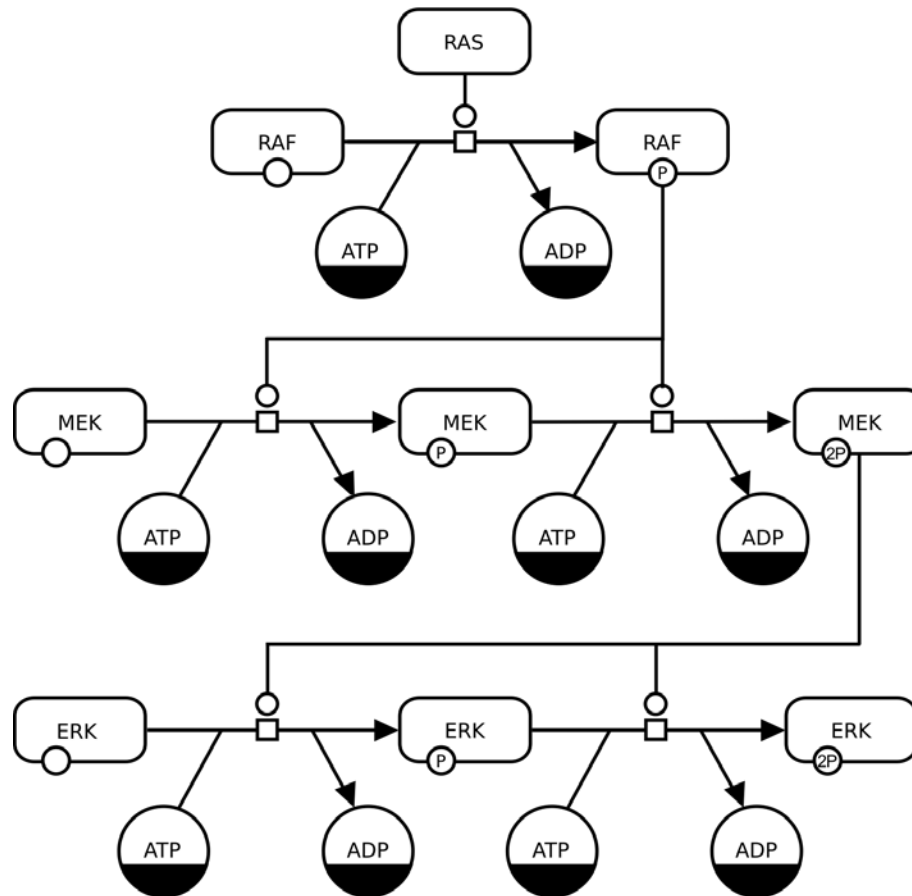

Level 1 Version 2.0

Process Duplication

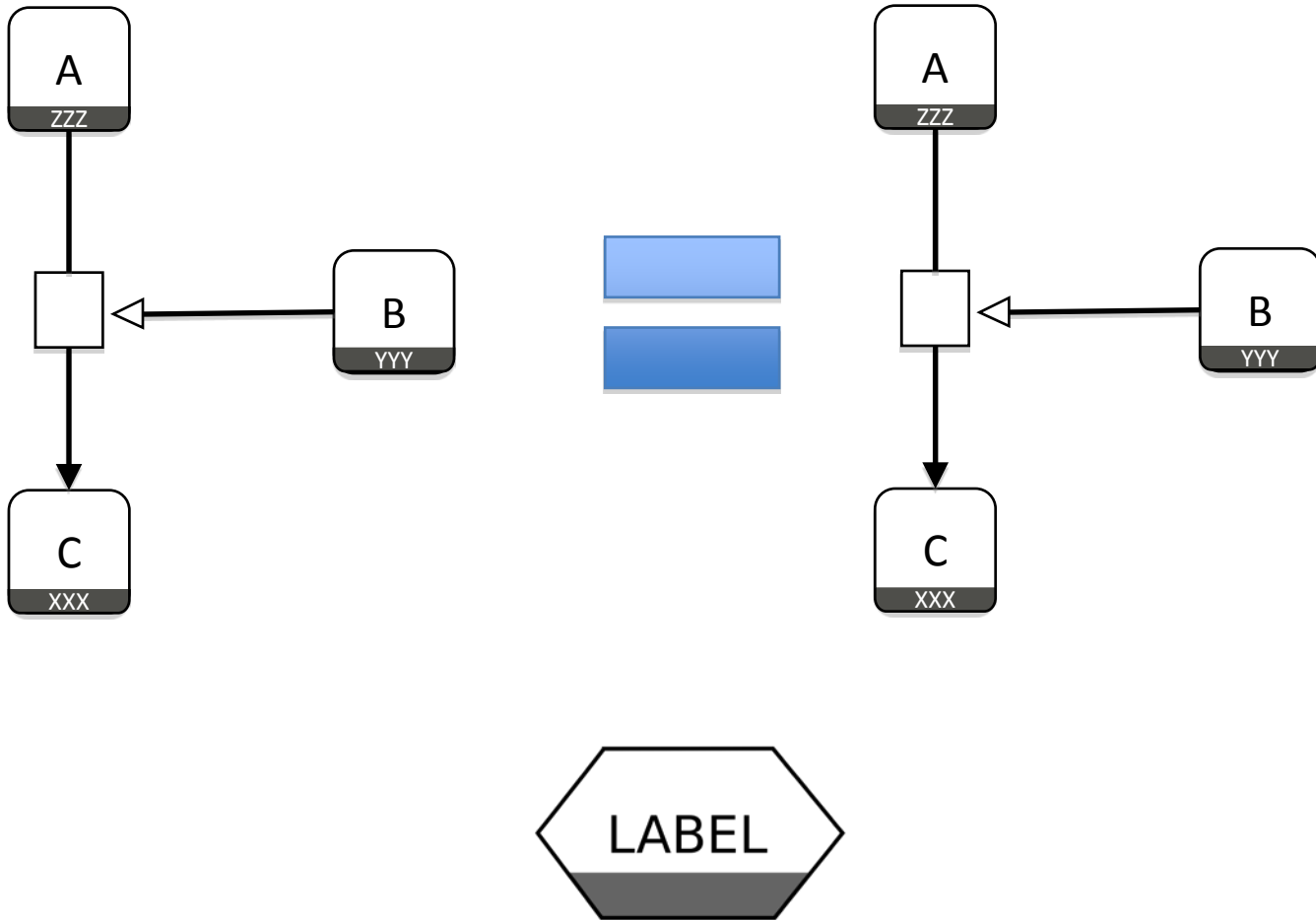

Unresolved Issues

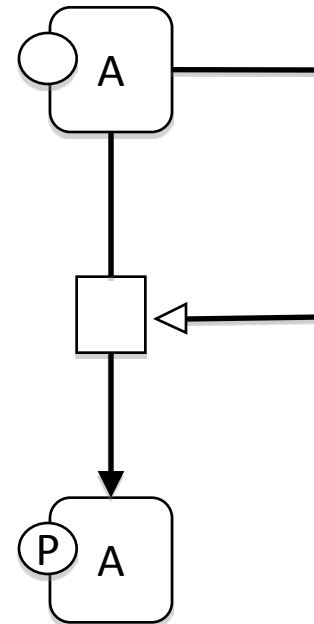
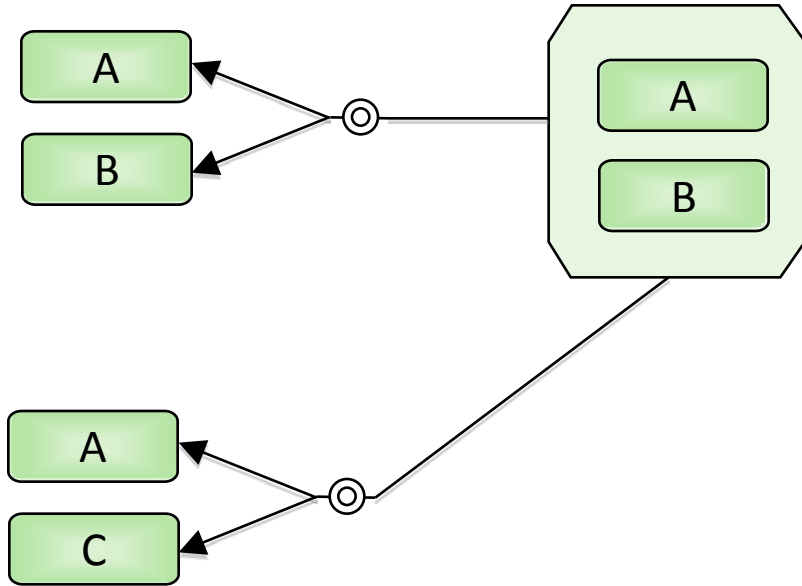

Road Map for PD

- Level 1 Version 2.0
 - Draft for Review: Min Nov
 - RFC: 2-3 Weeks
 - Release Xmas 2010
- Level 2 Version 1.0
 - Theme: RISC notation?
 - Start work in NYC 2011
 - Release First Draft COMINE 2011